

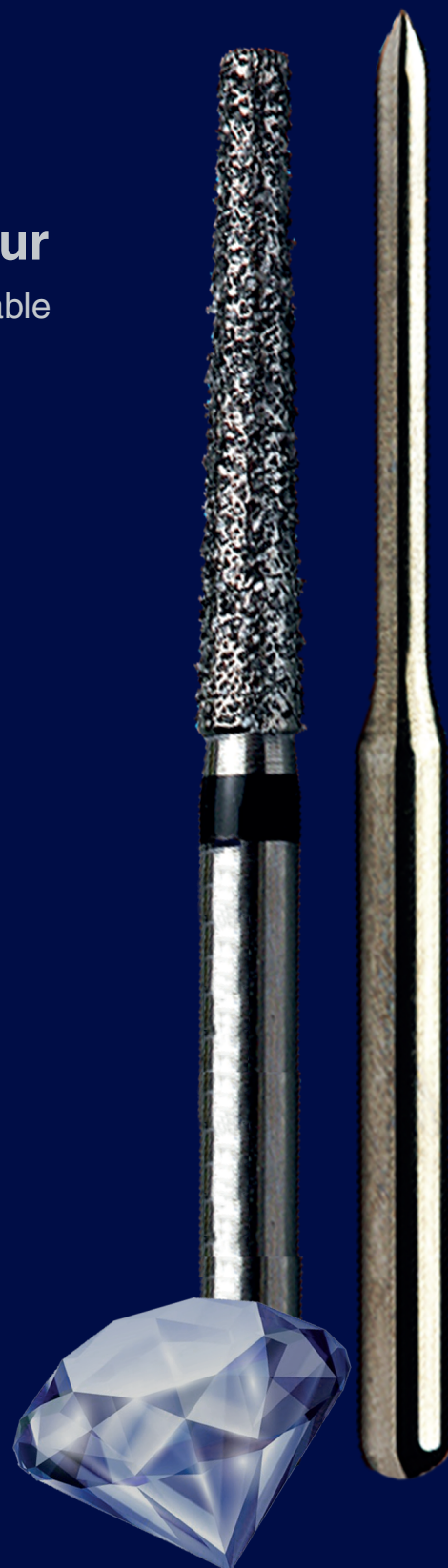

**Diamond Bur**  
sharper and durable



ISO 13485  
CE 0197

Diamond Dental Instruments

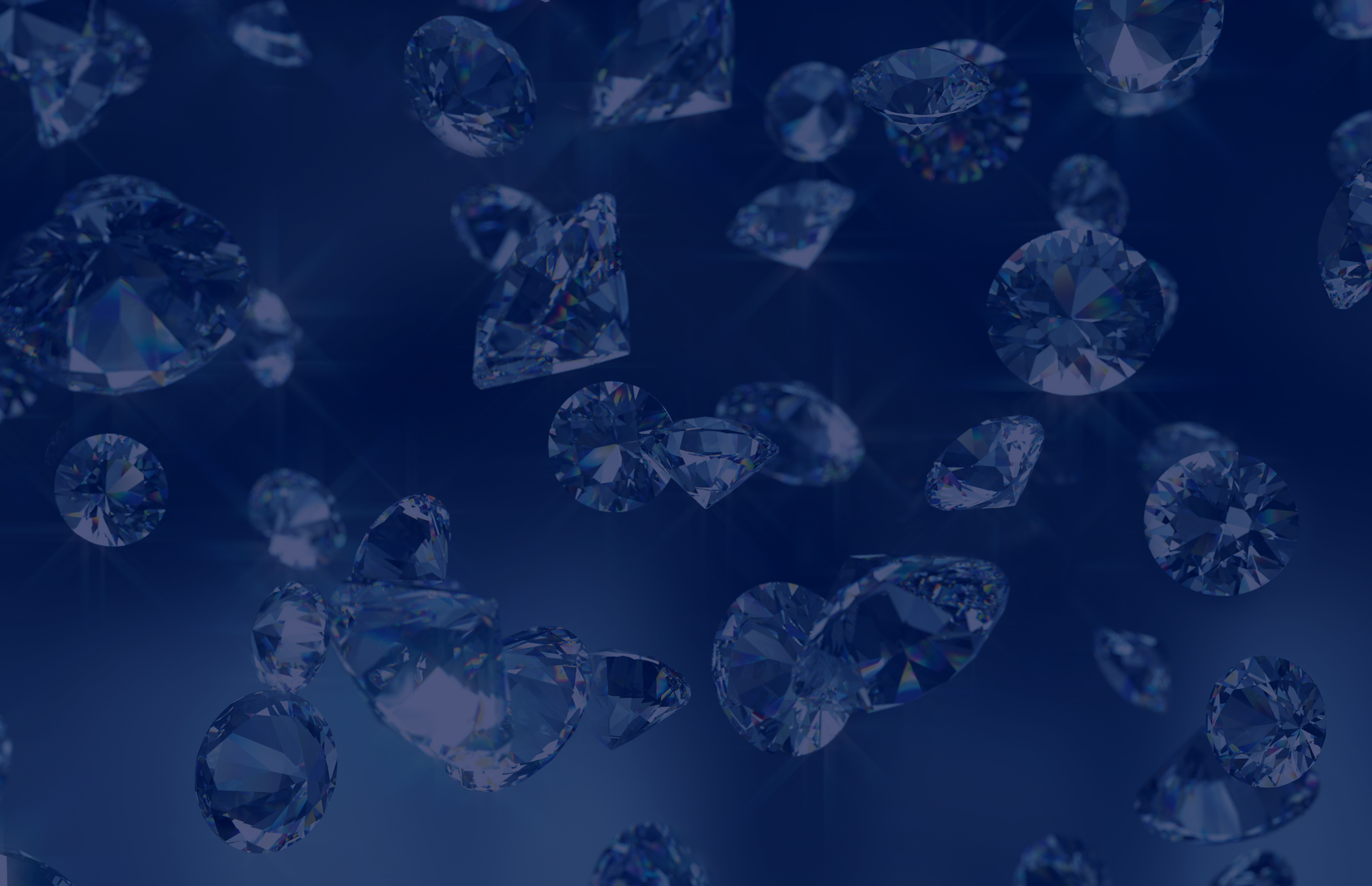



Ball Round

**801**



Code No	801	801	801	801	801	801	801	801	801
Head Diameter	008	010	012	014	016	018	021	025	029
Head Lentgh	-	-	-	-	-	-	-	-	-
Order Code	BR_49	BR_45	BR_46	BR_41	BR_40	BR_31	BR_28	BR_25	BR_23

Single Inverted Cone

**805**



Code No	805	805	805	805	805
Head Diameter	010	012	014	016	016
Head Lentgh	1.0	1.2	1.6	1.8	1.8
Order Code	SI_45	SI_46	SI_47	SI_48	SI_48S

Ball Round

**801**



Code No	801	801	801	801	801	801
Head Diameter	014	018	021	023	025	029
Head Lentgh	-	-	-	-	-	-
Order Code	BR_41S	BR_31S	BR_28S	BR_26S	BR_25S	BR_23S

Double Inverted Cone

**806**



Code No	806	806
Head Diameter	010	014
Head Lentgh	2.3	3.2
Order Code	DI_41	DI_42

Ball Collar

**802**



Code No	802	802
Head Diameter	016	014
Head Lentgh	8.0	8.0
Order Code	BC_12	BC_11

Ball Round

**801**



Code No	801	801	801	801	801	801
Head Diameter	014	016	018	021	025	029
Head Lentgh	-	-	-	-	-	-
Order Code	BR_41C	BR_40C	BR_31C	BR_28C	BR_25C	BR_23C

Ball Collar

**802**



Code No	802	802	802	802
Head Diameter	012	014	016	018
Head Lentgh	2.3	2.3	3.5	2.3
Order Code	BC_43	BC_42	BC_32	BC_31

Extra Shape Pearl

**830R**



Code No	830R
Head Diameter	032
Head Lentgh	5.0
Order Code	EX_26

Ball Round

**801L**



Code No	801L	801L	801L	801L	801L	801L	801L	801L
Head Diameter	018	018	016	016	016	014	010	012
Head Lentgh	-	-	-	-	-	-	-	-
Order Code	BR_X31	BR_X31C	BR_X40C	BR_X40	BR_X40S	BR_X41	BR_X45	BR_X46

Extra Shape Cylinders

**839**



Code No	839
Head Diameter	012
Head Lentgh	10.0
Order Code	EX_18

Depth Marking

**834**



Code No	834	834	834
Head Diameter	016	018	021
Head Lentgh	6.0	6.0	6.0
Order Code	VP_20	VP_21	VP_22

Taper Round End



<b>855</b>		
Code No	855	855
Head Diameter	018	020
Head Lentgh	6.5	6.5
Order Code	TR_62	TR_63

Taper Round End



<b>850</b>		
Code No	850	850
Head Diameter	014	016
Head Lentgh	9.0	9.0
Order Code	TR_11S	TR_12S

Extra Shape Barrel



<b>811</b>				
Code No	811	811	811	811
Head Diameter	032	035	035	032
Head Lentgh	5.0	7.0	7.0	5.0
Order Code	EX_11	EX_12	EX_12S	EX_11S

Taper Round End



<b>850L</b>		
Code No	850L	850L
Head Diameter	022	024
Head Lentgh	11.0	11.0
Order Code	TR_15	TR_19

Football



<b>379</b>		
Code No	379	379
Head Diameter	020	030
Head Lentgh	5.0	5.0
Order Code	TR_22	TR_28

Wheel Flat Edge



<b>815</b>				
Code No	815	909	909	909
Head Diameter	025	045	042	040
Head Lentgh	0.5	2.0	1.8	1.4
Order Code	WF_30	WR_44	WR_13	WR_12

Taper Round End



<b>850</b>			
Code No	850	850	850
Head Diameter	014	016	018
Head Lentgh	8.0	8.0	8.0
Order Code	TR_25	TR_32	TR_34

Taper Round End



<b>379</b>	
Code No	379
Head Diameter	020
Head Lentgh	3.9
Order Code	TR_22S

Taper Round End



<b>855</b>		
Code No	855	855
Head Diameter	014	016
Head Lentgh	6.5	6.5
Order Code	TR_20	TR_21

Taper Round End



<b>856</b>		
Code No	856	856
Head Diameter	018	016
Head Lentgh	8.0	8.0
Order Code	TR_23	TR_24

Taper Round End



<b>856</b>	
Code No	856
Head Diameter	018
Head Lentgh	9.0
Order Code	TR_13C

Straight Round End



<b>838</b>			
Code No	838	838	838
Head Diameter	010	012	014
Head Lentgh	4.0	4.0	4.0
Order Code	SR_41	SR_31	SR_42

Taper Round End



<b>855</b>	
Code No	855
Head Diameter	016
Head Lentgh	6.5
Order Code	TR_21S

Taper Round End



<b>850</b>				
Code No	850	850	850	850
Head Diameter	014	016	018	022
Head Lentgh	9.0	9.0	9.0	9.0
Order Code	TR_11	TR_12	TR_13	TR_14

Straight Flat End



**835**

Code No	835	835
Head Diameter	012	014
Head Lentgh	4.0	4.0
Order Code	SF_31S	SF_42S

Straight Flat End



**837**

Code No	837	837	837
Head Diameter	012	014	016
Head Lentgh	8.0	8.0	8.0
Order Code	SF_11S	SF_12S	SF_13S

Straight Round End



**881**

Code No	881	881	881	881
Head Diameter	012	014	014	016
Head Lentgh	8.0	6.0	8.0	8.0
Order Code	SR_11	SR_12	SR_12	SR_13

Straight Ogival End



**886**

Code No	886
Head Diameter	018
Head Lentgh	9.5
Order Code	SO_16

Straight Flat End



**835**

Code No	835	835	835	835	835	835
Head Diameter	007	008	010	014	012	009
Head Lentgh	4.0	4.0	4.0	4.0	4.0	4.0
Order Code	SF_49	SF_46	SF_41	SF_42	SF_31	SF_45

Straight Ogival End



**885**

Code No	885
Head Diameter	012
Head Lentgh	7.0
Order Code	SO_11

Straight Ogival End



**877**

Code No	877	877
Head Diameter	012	014
Head Lentgh	6.0	6.0
Order Code	SO_20	SO_21

Taper Flat Cone



**847K**

Code No	847K
Head Diameter	016
Head Lentgh	5.5
Order Code	847K_16

Straight Flat End



**837**

Code No	837	837	837	837
Head Diameter	012	014	014	016
Head Lentgh	8.0	6.0	8.0	8.0
Order Code	SF_11	SF_12	SF_12C	SF_13

Tor Pedro



**879k**

Code No	879k	879k	879k
Head Diameter	014	016	018
Head Lentgh	10.0	10.0	10.0
Order Code	879K_14	879K_16	879K_18

Tor Pedro



**878k**

Code No	878k	878k
Head Diameter	016	018
Head Lentgh	8.0	8.0
Order Code	879K_16	879K_18

Straight Flat End



**836**

Code No	836	836
Head Diameter	016	014
Head Lentgh	6.0	6.0
Order Code	SF_15	SF_21

Taper Round Edge



**848KR**

Code No	848KR
Head Diameter	016
Head Lentgh	8.0
Order Code	848KR_16

Extra Shape Pearl



**830**

Code No	830	830
Head Diameter	010	014
Head Lentgh	2.8	4.0
Order Code	EX_41	EX_31

Extra Shape Pearl



**830L**

Code No	830L	830L	830L
Head Diameter	018	018	021
Head Lentgh	5.0	5.0	5.0
Order Code	EX_20	EX_20S	EX_21

Taper Flat End



**848**

Code No	848	848
Head Diameter	016	018
Head Lentgh	10.0	10.0
Order Code	TF_12	TF_13

Taper Flat End



**848**

Code No	848	848	848
Head Diameter	014	014	018
Head Lentgh	10.0	10.0	10.0
Order Code	TF_11	TF_11S	TF_13S

Toper conical End / Needle



**859**

Code No	859	859	859L	859	859
Head Diameter	014	016	010	016	018
Head Lentgh	10.0	10.0	12.0	10.0	10.0
Order Code	TC_10	TC_11	TC_12	TC_14	TC_16

Taper Flat End



**846**

Code No	846	846	846	846	846
Head Diameter	014	016	016	018	021
Head Lentgh	6.5	6.5	6.5	5.0	5.0
Order Code	TF_20	TF_21	TF_21S	TF_23	TF_22

Toper conical End / Needle



**859**

Code No	859	859	859	859
Head Diameter	016	014	012	018
Head Lentgh	10.0	10.0	10.0	10.0
Order Code	TC_11S	TC_12S	TC_13S	TC_16S

Toper conical End / Needle



**852**

Code No	852
Head Diameter	012
Head Lentgh	6.0
Order Code	TC_26

Taper Flat End



**845**

Code No	845	845	845	845
Head Diameter	010	012	016	014
Head Lentgh	4.0	4.0	4.0	4.0
Order Code	TF_41	TF_42	TF_31	TF_43

Taper Flat End



**847**

Code No	847
Head Diameter	008
Head Lentgh	8.0
Order Code	TF_06

Toper conical End / Needle



**858**

Code No	858	858
Head Diameter	014	014
Head Lentgh	8.0	8.0
Order Code	TC_21C	TC_21

Toper conical End / Needle



**859**

Code No	859	859
Head Diameter	010	012
Head Lentgh	10.0	10.0
Order Code	TC_27	TC_28

Taper Round End



**855**

Code No	855	855
Head Diameter	016	014
Head Lentgh	6.5	6.5
Order Code	TR_21F	TR_20F

Taper Round End



**850**

Code No	850	850
Head Diameter	016	018
Head Lentgh	10	10
Order Code	TR_12F	TR_13F

Taper Flat End



**847**

Code No	847	847	847	847	847
Head Diameter	010	012	014	016	023
Head Lentgh	8.0	8.0	8.0	8.0	9.0
Order Code	TF_07	TF_08	TF_09	TF_10	TF_14

Extra Shape  
Cylinders



**839**

Code No	839
Head Diameter	012
Head Lentgh	10.0
Order Code	EX_18F

Flame Ogival End



**862**

Code No	862	862
Head Diameter	014	016
Head Lentgh	8.0	8.0
Order Code	FO_21F	FO_22F

Taper Conical End



**858**

Code No	858
Head Diameter	014
Head Lentgh	8.0
Order Code	TC_21F

Taper Conical End



**859**

Code No	859
Head Diameter	016
Head Lentgh	10.0
Order Code	TC_11F

Taper Round End



**850L**

Code No	850L
Head Diameter	022
Head Lentgh	6.5
Order Code	TR_61F

Football



**368**

Code No	368
Head Diameter	016
Head Lentgh	3.2
Order Code	FO_30F

Flame Ogival End



**862**

Code No	862	862
Head Diameter	014	016
Head Lentgh	8.0	8.0
Order Code	FO_21EF	FO_22EF

Taper Flat End

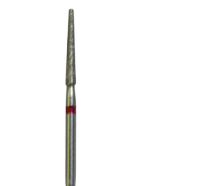

**848**

Code No	848	848
Head Diameter	014	016
Head Lentgh	10.0	10.0
Order Code	TF_11F	TF_12F

Taper Flat End

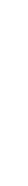

**848**

Code No	848
Head Diameter	018
Head Lentgh	10.0
Order Code	TF_13F

Taper Round End



**855**

Code No	855
Head Diameter	016
Head Lentgh	6.5
Order Code	TR_21EF

Taper Round End



**850**

Code No	850
Head Diameter	014
Head Lentgh	10.0
Order Code	TR_EF

Taper Round End



**856**

Code No	856
Head Diameter	016
Head Lentgh	8.0
Order Code	TR_24EF

Taper Round End



**855**

Code No	855
Head Diameter	018
Head Lentgh	6.5
Order Code	TR_62F

Inlay Preparation



**849**

Code No	849
Head Diameter	016
Head Lentgh	4.0
Order Code	CR_12F

Straight Ogival End



**878**

Code No	878
Head Diameter	014
Head Lentgh	8.0
Order Code	SO_21F

Taper Round End



**855**

Code No	855
Head Diameter	022
Head Lentgh	6.5
Order Code	TR_61EF

Football



**368**

Code No	368	368
Head Diameter	016	023
Head Lentgh	3.2	5.0
Order Code	FO_30EF	FO_34EF

Straight Flat End



**836**

Code No	836
Head Diameter	014
Head Lentgh	6.0
Order Code	SF_21F

Extra Shape Pearl



**830L**

Code No	830L	830RL
Head Diameter	014	021
Head Lentgh	4.0	5.0
Order Code	EX_31F	EX_21F



Flame Ogival End



**860**

Code No	860
Head Diameter	012
Head Lentgh	6.0
Order Code	FO_41EF

Football



**368**

Code No	368
Head Diameter	018
Head Lentgh	3.6
Order Code	FO_32C

Flame Ogival End



**889**

Code No	889
Head Diameter	010
Head Lentgh	4.3
Order Code	FO_40EF

Extra Shape Pearl



**830RL**

Code No	830RL
Head Diameter	021
Head Lentgh	5.0
Order Code	EX_21EF

Taper Conical End



**859**

Code No	859
Head Diameter	016
Head Lentgh	10.0
Order Code	TC_11EF

Taper Conical End



**858**

Code No	858
Head Diameter	014
Head Lentgh	8.0
Order Code	TC_21EF

Football



**368**

Code No	368	368	368
Head Diameter	018	023	028
Head Lentgh	3.6	5.0	5.0
Order Code	FO_32	FO_34	FO_25

Flame Ogival End



**860**

Code No	860	860
Head Diameter	012	014
Head Lentgh	6.0	6.0
Order Code	FO_41	FO_20

Taper Conical End



**859**

Code No	859	859
Head Diameter	010	012
Head Lentgh	10.0	10.0
Order Code	TC_27EF	TC_28EF

Flame Ogival End



**190**

Code No	190
Head Diameter	018
Head Lentgh	9.5
Order Code	FO_54C

Taper Flat End



**846**

Code No	846
Head Diameter	016
Head Lentgh	6.5
Order Code	TF_21EF

Flame Ogival End



**862**

Code No	862	862
Head Diameter	014	016
Head Lentgh	8.0	8.0
Order Code	FO_21	FO_22

Flame Ogival End



**863**

Code No	863	863
Head Diameter	014	016
Head Lentgh	10.0	10.0
Order Code	FO_12	FO_13

Taper Flat End



**848**

Code No	848
Head Diameter	018
Head Lentgh	10.0
Order Code	TF_13EF

Taper Flat End



**848**

Code No	848
Head Diameter	016
Head Lentgh	8.0
Order Code	TF_12EF

Taper Flat End



**848**

Code No	848
Head Diameter	014
Head Lentgh	10.0
Order Code	TF_11EF

Inlay Preparation

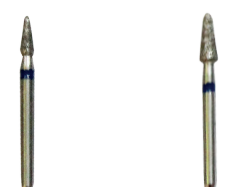

**849**

Code No	849	849
Head Diameter	016	020
Head Lentgh	4.0	5.0
Order Code	CR_12	CR_11

Inlay Preparation



**849**

Code No	849	849
Head Diameter	012	014
Head Lentgh	4.0	4.0
Order Code	CR_31	CR_42

Inlay Preparation



**849**

Code No	849	849
Head Diameter	020	016
Head Lentgh	5.0	4.0
Order Code	CR_11EF	CR_12EF

Flame Ogival End



**860**

Code No	860
Head Diameter	014
Head Lentgh	6.0
Order Code	FO_20EF